



WAVE 125i

Owner's Manual Manual Pemilik

Read before you ride!

Baca sebelum menunggang!

Use Only Honda Genuine Parts

Gunakan minyak
pelincir honda untuk
prestasi lebih unggul



This manual should be considered a permanent part of the motorcycle and should remain with the motorcycle when it is resold.

This publication includes the latest production information available before printing. Honda Motor Co., Ltd. reserves the right to make changes at any time without notice and without incurring any obligation.

No part of this publication may be reproduced without written permission.

The vehicle pictured in this owner's manual may not match your actual vehicle.

Welcome

Congratulations on your purchase of a new Honda motorcycle. Your selection of a Honda makes you part of a worldwide family of satisfied customers who appreciate Honda's reputation for building quality into every product.

To ensure your safety and riding pleasure:

- Read this owner's manual carefully.
- Follow all recommendations and procedures contained in this manual.
- Pay close attention to safety messages contained in this manual and on the motorcycle.

- The following codes in this manual indicate the country.
- The illustrations here in are based on the AFS125MCR MA type.

Country Codes

Code	Country
AFS125MCS	
MA	Malaysia
AFS125MCR	
MA	Malaysia

A Few Words About Safety

Your safety, and the safety of others, is very important. Operating this motorcycle safely is an important responsibility.

To help you make informed decisions about safety, we have provided operating procedures and other information on safety labels and in this manual. This information alerts you to potential hazards that could hurt you or others.

Of course, it is not practical or possible to warn you about all hazards associated with operating or maintaining a motorcycle. You must use your own good judgement.

You will find important safety information in a variety of forms, including:

- Safety labels on the motorcycle
- Safety Messages preceded by a safety alert symbol  and one of three signal words: DANGER, WARNING, or CAUTION.

These signal words mean:

DANGER

You **WILL** be **KILLED** or **SERIOUSLY HURT** if you don't follow instructions.

WARNING

You **CAN** be **KILLED** or **SERIOUSLY HURT** if you don't follow instructions.

CAUTION

You **CAN** be **HURT** if you don't follow instructions.

Other important information is provided under the following titles:

NOTICE

Information to help you avoid damage to your motorcycle, other property, or the environment.

Contents

Motorcycle Safety P. 2

Operation Guide P. 12

Maintenance P. 32

Troubleshooting P. 70

Information P. 90

Specifications P. 101

Index P. 104

Motorcycle Safety

This section contains important information for safe riding of your motorcycle.
Please read this section carefully.

Safety Guidelines	P. 3
Safety Precautions	P. 6
Riding Precautions.....	P. 7
Accessories & Modifications.....	P. 10
Loading	P. 11

Safety Guidelines

Follow these guidelines to enhance your safety:

- Perform all routine and regular inspections specified in this manual.
- Stop the engine and keep sparks and flame away before filling the fuel tank.
- Do not run the engine in enclosed or partly enclosed areas. Carbon monoxide in exhaust gases is toxic and can kill you.

Always Wear a Helmet

It's a proven fact: helmets and protective apparel significantly reduce the number and severity of head and other injuries. So always wear an approved motorcycle helmet and protective apparel. 📖 P. 6

Before Riding

Make sure that you are physically fit, mentally focused and free of alcohol and drugs. Check

that you and your passenger are both wearing an approved motorcycle helmet and protective apparel. Instruct your passenger on holding onto the grab rail or your waist, leaning with you in turns, and keeping their feet on the footpegs, even when the motorcycle is stopped.

Take Time to Learn & Practice

Even if you have ridden other motorcycles, practice riding in a safe area to become familiar with how this motorcycle works and handles, and to become accustomed to the motorcycle's size and weight.

Ride Defensively

Always pay attention to other vehicles around you, and do not assume that other drivers see you. Be prepared to stop quickly or perform an evasive maneuver.

Safety Guidelines

Make Yourself Easy to See

Make yourself more visible, especially at night, by wearing bright reflective clothing, positioning yourself so other drivers can see you, signaling before turning or changing lanes, and using your horn when necessary.

Ride within Your Limits

Never ride beyond your personal abilities or faster than conditions warrant. Fatigue and inattention can impair your ability to use good judgement and ride safely.

Don't Drink and Ride

Alcohol and riding don't mix. Even one alcoholic drink can reduce your ability to respond to changing conditions, and your reaction time gets worse with every additional drink. Don't drink and ride, and don't let your friends drink and ride either.

Keep Your Honda in Safe Condition

It's important to keep your motorcycle properly maintained and in safe riding condition. Inspect your motorcycle before every ride and perform all recommended maintenance. Never exceed load limits (➤ P. 11), and do not modify your motorcycle or install accessories that would make your motorcycle unsafe (➤ P. 10).

If You are Involved in a Crash

Personal safety is your first priority. If you or anyone else has been injured, take time to assess the severity of the injuries and whether it is safe to continue riding. Call for emergency assistance if needed. Also follow applicable laws and regulations if another person or vehicle is involved in the crash.

If you decide to continue riding, first turn the ignition switch to the **○** (Off) position, and evaluate the condition of your motorcycle.

Inspect for fluid leaks, check the tightness of critical nuts and bolts, and check the handlebar, control levers, brakes, and wheels. Ride slowly and cautiously.

Your motorcycle may have suffered damage that is not immediately apparent. Have your motorcycle thoroughly checked at a qualified service facility as soon as possible.

Carbon Monoxide Hazard

Exhaust contains poisonous carbon monoxide, a colourless, odorless gas. Breathing carbon monoxide can cause loss of consciousness and may lead to death.

If you run the engine in confined or even partly enclosed area, the air you breathe could contain a dangerous amount of carbon monoxide. Never run your motorcycle inside a garage or other enclosure.

WARNING

Running the engine of your motorcycle while in an enclosed or even partially enclosed area can cause a rapid build-up of toxic carbon monoxide gas.

Breathing this colourless, odorless gas can quickly cause unconsciousness and lead to death.

Only run your motorcycle's engine when it is located in a well ventilated area outdoors.

Safety Precautions

- Ride cautiously and keep your hands on the handlebar and feet on the footpegs.
- Keep passenger's hands onto the grab rail or your waist, passenger's feet on the footpegs while riding.
- Always consider the safety of your passenger, as well as other drivers and riders.

Protective Apparel

Make sure that you and any passenger are wearing an approved motorcycle helmet, eye protection, and high-visibility protective clothing. Ride defensively in response to weather and road conditions.

■ Helmet

Safety-standard certified, high-visibility, correct size for your head

- Must fit comfortably but securely, with the chin strap fastened.

- Face shield with unobstructed field of vision or other approved eye protection

WARNING

Not wearing a helmet increases the chance of serious injury or death in a crash.

Make sure that you and any passenger always wear an approved helmet and protective apparel.

■ Gloves

Full-finger leather gloves with high abrasion resistance

■ Boots or Riding Shoes

Sturdy boots with non-slip soles and ankle protection

■ Jacket and Trousers

Protective, highly visible, long-sleeved jacket and durable trousers for riding (or a protective suit)

Riding Precautions

Running-in Period

During the first 500 km (300 miles) of running, follow these guidelines to ensure your motorcycle's future reliability and performance.

- Avoid full-throttle starts and rapid acceleration.
- Avoid hard braking and rapid down-shifts.
- Ride conservatively.

Brakes

Observe the following guidelines:

- Avoid excessively hard braking and downshifting.
 - ▶ Sudden braking can reduce the motorcycle's stability.
 - ▶ Where possible, reduce speed before turning; otherwise you risk sliding out.

- Exercise caution on low traction surfaces.
 - ▶ The tyres slip more easily on such surfaces and braking distances are longer.
- Avoid continuous braking.
 - ▶ Repeated braking, such as when descending long, steep slopes can seriously overheat the brakes, reducing their effectiveness. Use engine braking with intermittent use of the brakes to reduce speed.
- For full braking effectiveness, operate both the front and rear brakes together.

Riding Precautions

Engine Braking

Engine braking helps slow your motorcycle down when you release the throttle. For further slowing action, downshift to a lower gear. Use engine braking with intermittent use of the brakes to reduce speed when descending long, steep slopes.

Wet or Rainy Conditions

Road surfaces are slippery when wet, and wet brakes further reduce braking efficiency. Exercise extra caution when braking in wet conditions.

If the brakes get wet, apply the brakes while riding at low speed to help them dry.

Parking

- Park on a firm, level surface.
- If you must park on a slight incline or loose surface, park so that the motorcycle cannot move or fall over.
- Make sure that high-temperature parts cannot come into contact with flammable materials.
- Do not touch the engine, muffler, brakes and other high-temperature parts until they cool down.
- To reduce the likelihood of theft, always lock the handlebar and remove the key and close the shutter when leaving the motorcycle unattended.
Use of an anti-theft device is also recommended.

Parking with the Side Stand or Centre Stand

1 Stop the engine.

2 Using the side stand

Push the side stand down.

Slowly lean the motorcycle to the left until its weight rests on the side stand.

Using the centre stand

To lower the centre stand, stand on the left side of the motorcycle. Hold the left handle grip and the grab rail. Press down on the tip of the centre stand with your right foot and, simultaneously, pull up and back.

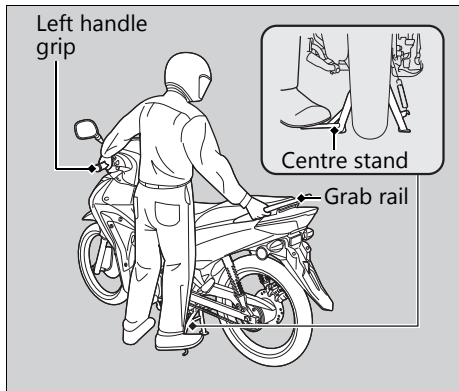

3. Turn the handlebar fully to the left.
 - ▶ Turning the handlebar to the right reduces stability and may cause the motorcycle to fall.
4. Turn the ignition switch to the  (Lock) position (➤ P. 21), remove the key and close the shutter (➤ P. 22).

Refuelling and Fuel Guidelines

Follow these guidelines to protect the engine, fuel system and catalytic converter:

- Use only unleaded petrol.
- Use recommended octane number. Using lower octane petrol will result in decreased engine performance.
- Do not use fuels containing a high concentration of alcohol. ➤ P. 99
- Do not use stale or contaminated petrol or an oil/petrol mixture.
- Avoid getting dirt or water in the fuel tank.

Accessories & Modifications

We strongly advise that you do not add any accessories that were not specifically designed for your motorcycle by Honda or make modifications to your motorcycle from its original design. Doing so can make it unsafe. Modifying your motorcycle may also void your warranty and make your motorcycle illegal to operate on public roads. Before deciding to install accessories on your motorcycle be certain the modification is safe and legal.

WARNING

Improper accessories or modifications can cause a crash in which you can be seriously hurt or killed.

Follow all instructions in this owner's manual regarding accessories and modifications.

Do not pull a trailer with, or attach a sidecar to, your motorcycle. Your motorcycle was not designed for these attachments, and their use can seriously impair your motorcycle's handling.

Loading

- Carrying extra weight affects your motorcycle's handling, braking and stability. Always ride at a safe speed for the load you are carrying.
- Avoid carrying an excessive load and keep within specified load limits.
Maximum weight capacity/Maximum luggage weight 📖 P. 101
- Tie all luggage securely, evenly balanced and close to the centre of the motorcycle.
- Do not place objects near the lights or the muffler.

WARNING

Overloading or improper loading can cause a crash and you can be seriously hurt or killed.

Follow all load limits and other loading guidelines in this manual.



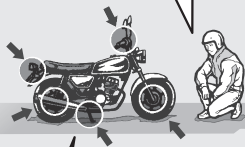

Basic Operation Flow

Pre-ride Inspection P.37

Carefully inspect your motorcycle to make sure that it is safe to ride.



How to use basic features.

- Instruments  P.18
- Indicators  P.19
- Switches  P.20
- Steering Lock  P.21
- Shutter  P.22

Acceleration

Apply throttle gradually.
Obey the speed limit.



Shift Change P.26



Starting the Engine P.23

Start and warm the engine.
Avoid revving the engine.



Starting the Motorcycle

Before pulling away, indicate your direction with the turn signal switch, and check for oncoming traffic.

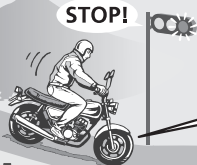
Braking

Close the throttle and apply the front and rear brakes together.

- ▶ The brakelight will indicate that you have applied the brakes.

Stopping

If pulling off the road, signal early enough to show traffic that you are pulling over, and pull over smoothly.

**Turning Corners**

Do your braking before entering corners.

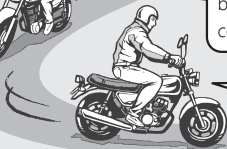

Gradually reapply throttle when exiting turn.

Parking → P.8

Park on a firm level surface. Use the stand and lock the steering.

**Refuelling** → P.27

Parts Location

AFS125MCS

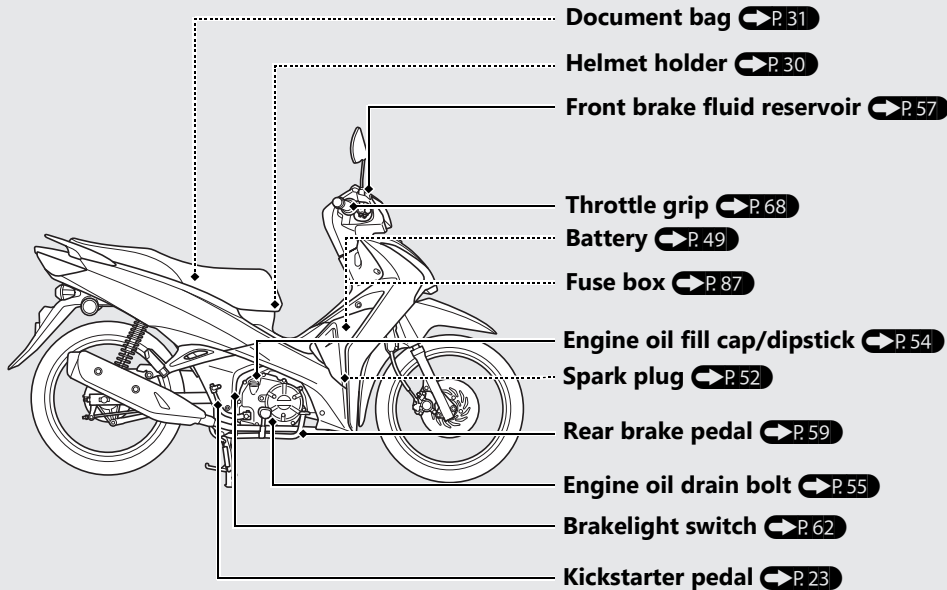

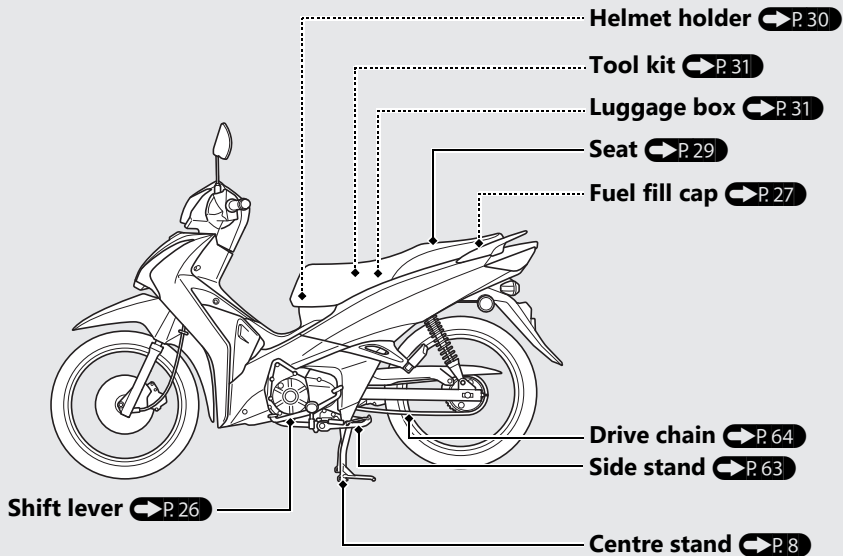

Parts Location *(Continued)*

AFS125MCR

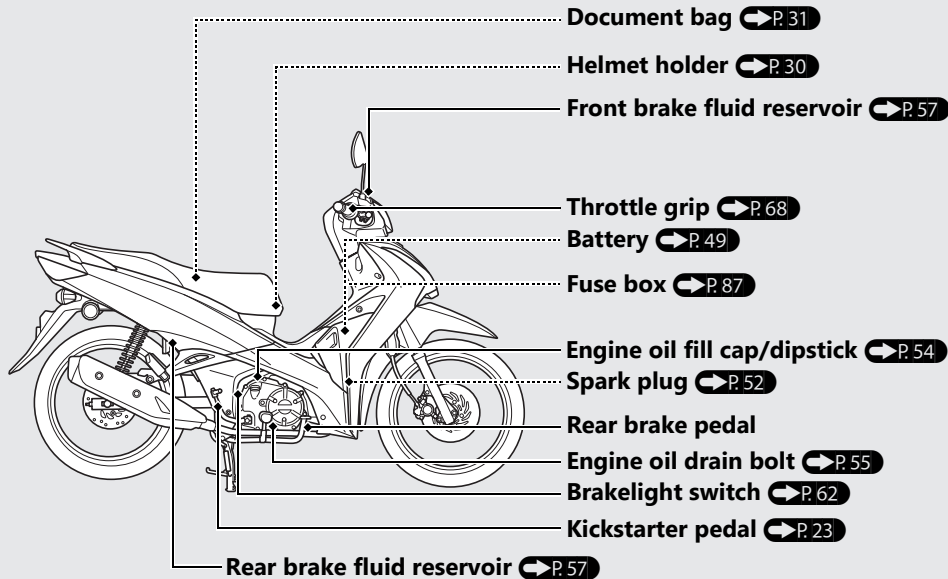

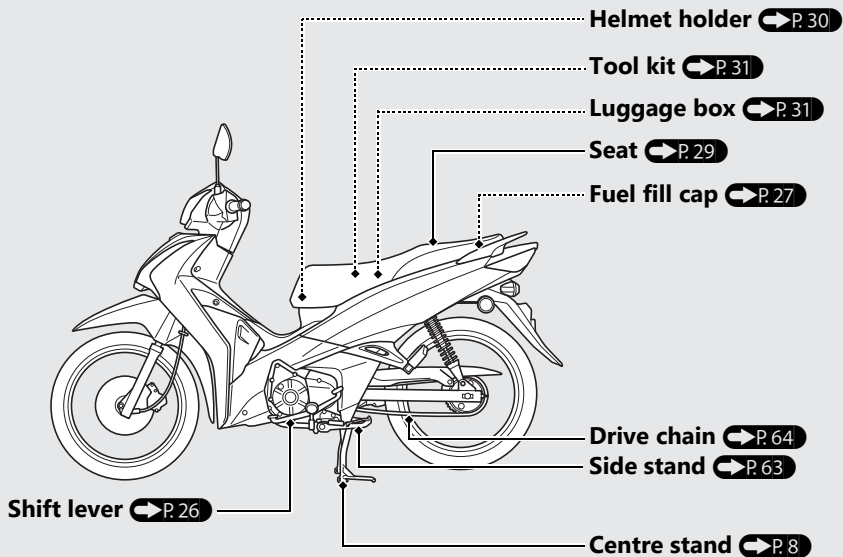

Instruments

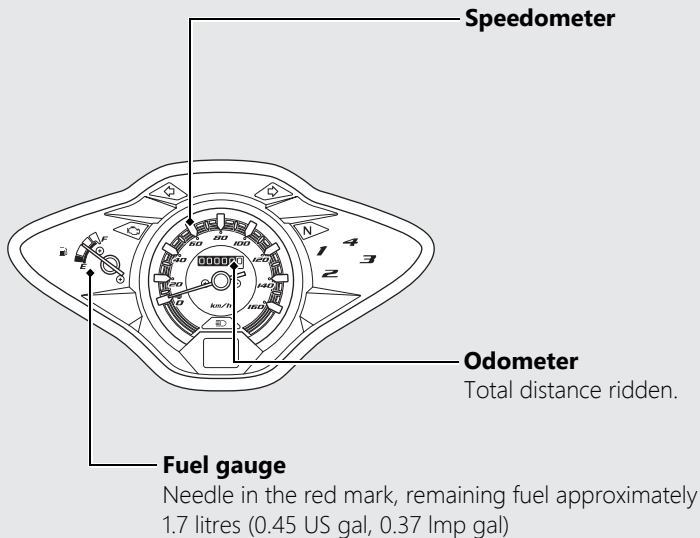

Indicators

If one of these indicators does not come on when it should, have your dealer check for problems.

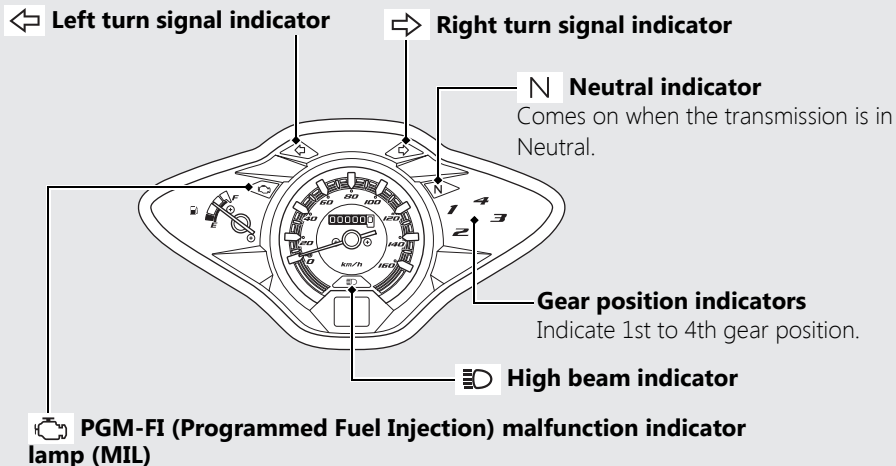

Comes on briefly when the ignition switch is turned to the **I** (On) position.

If it comes on while engine is running: **P.72**

Switches

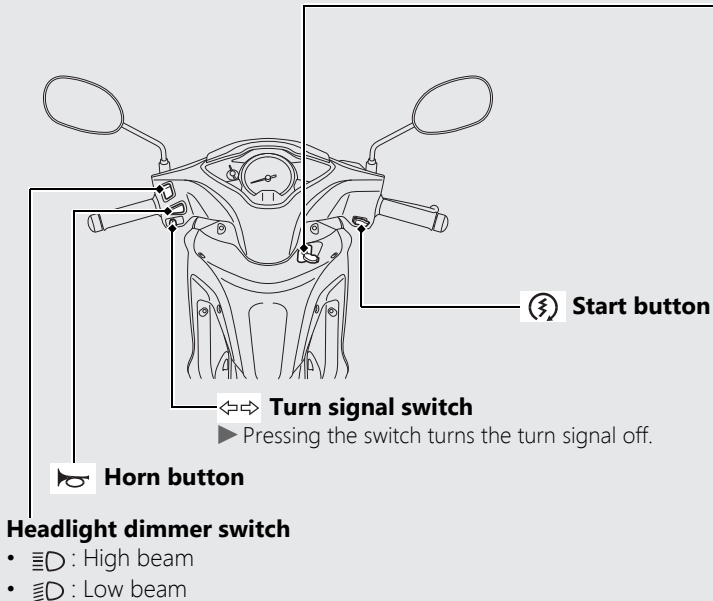

Ignition switch

Switches the electrical system on/off, locks the steering and operates the seat opener switch.

- ▶ Key can be removed when in the ○ (Off) or  (Lock) position.

Steering Lock

Lock the steering when parking to help prevent theft.

A U-shaped wheel lock or similar device is also recommended.

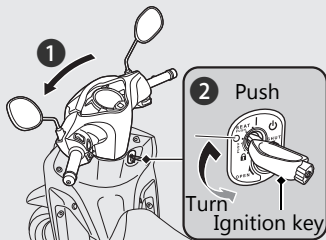

Turns electrical system on for starting/riding.

Operates the seat opener switch.

○ (Off)
Turns engine off.

 (Lock)
Locks steering.

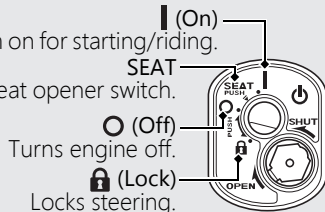

Locking

- 1 Turn the handlebar all the way to the left or right.
- 2 Push the key down, and turn the ignition switch to the  (Lock) position.
 - ▶ Jiggle the handlebar if the lock is difficult to engage.
- 3 Remove the key.

Unlocking

Insert the key, push it in, and turn the ignition switch to the ○ (Off) position.

Switches *(Continued)*

Shutter

The ignition switch for this motorcycle is equipped with an automatic shutter. After parking the motorcycle, close the shutter for theft prevention.

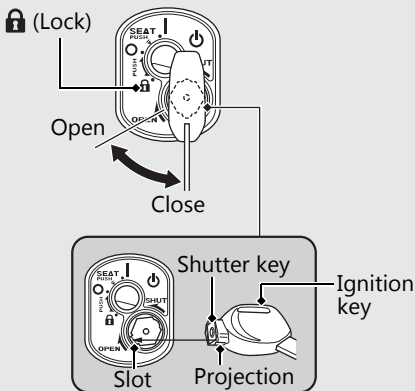

The shutter will automatically close when you remove the ignition key at the **(Lock)** position. Also you can close the shutter manually.

Close

- 1 Remove the ignition key from the ignition switch.
- 2 Align the projection of the shutter key with the slot of the shutter, and turn the shutter key counterclockwise.
- 3 Remove the key.

Open

Align the projection of the shutter key with the slot of the shutter, and turn the shutter key clockwise.

Starting the Engine

Start your engine using the following procedure, regardless of whether the engine is cold or warm.

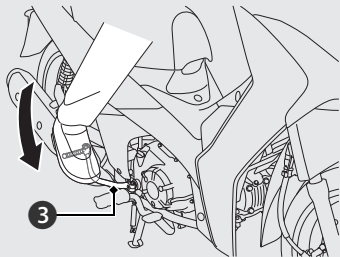
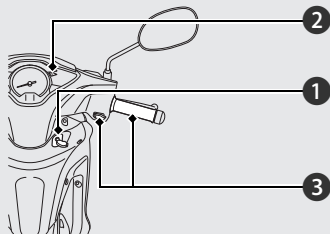

NOTICE

- If the engine does not start within 5 seconds, turn the ignition switch to the **O** (Off) position and wait 10 seconds before trying to start the engine again to recover battery voltage.
- Extended fast idling and revving the engine can damage the engine, and the exhaust system.
- Do not operate the kickstarter while the engine is running as engine damage could result. Do not apply excessive force on the kickstarter.
- Fold up the kickstarter after the kickstarter is returned to the pedal stop.

Consult your dealer for advice if you plan to ride your motorcycle at an altitude above 2,500 m (8,000 feet).

NOTICE

- If the motorcycle is transported to a place 2,000 m (6,500 feet) higher or lower than the start point, you may not be able to achieve sufficient engine performance at the new altitude. Consult your dealer before transporting your motorcycle.

Starting the Engine *(Continued)*

- 1 Turn the ignition switch to the **I** (On) position.
- 2 Shift the transmission to Neutral (**N** indicator comes on).

3 Using the start button

With the throttle completely closed, press the start button.

Using the kickstarter

Lightly depress the kickstarter until resistance is felt.

Then let kickstarter return to the top of its stroke.

With the throttle completely closed, operate the kickstarter starting from the top of the stroke, kick through to the bottom with a rapid, continuous motion.

If you cannot start the engine:

Open the throttle slightly (about 3 mm, without freeplay).

About 3 mm, without freeplay

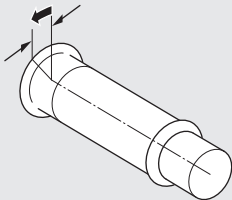
**If the engine does not start:**

- ① Turn the ignition switch to the **O** (Off) position.
- ② Open the throttle fully.
- ③ Crank the engine several times with the kickstarter.
- ④ Repeat the starting procedure.

- ⑤ If the engine starts, open the throttle slightly if idling is unstable.
- ⑥ If the engine does not start, wait 10 seconds before trying steps ①-④ again.

If Engine Will Not Start ➔ P.71

Shifting Gears

Your motorcycle transmission has four forward gears.

The gearshift operation differs when stopping and when moving.

When stopping, change can be made from 4th to neutral directly with the 4-step rotary system.

When moving, the forward 4-step return system is used.

Change cannot be made from 4th to neutral directly.

- ▶ Always return the throttle grip first before changing gear.
- ▶ Operate lightly with the tips of your toes until the shift lever is pushed down.
- ▶ Avoid changing gear needlessly and riding with your foot on the shift lever since this may damage the gear change mechanism and clutch mechanism.

Proper shifting can prevent damaging the engine and transmission.

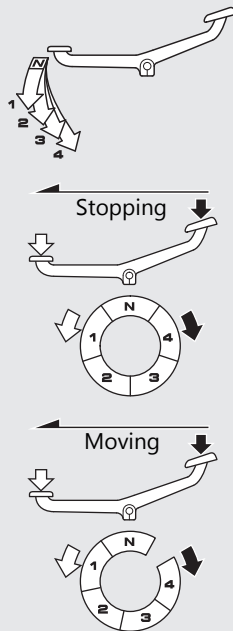

Refuelling

Fuel type: Unleaded petrol only

Fuel octane number: Your motorcycle is designed to use Research Octane Number (RON) 91 or higher.

Tank capacity: 5.4 litres (1.43 US gal, 1.19 Imp gal)

Refuelling and Fuel Guidelines P. 9

Opening the Fuel Fill Cap

- 1 Open the seat.  P. 29
- 2 Turn the fuel fill cap counterclockwise until it stops and remove the fuel fill cap.

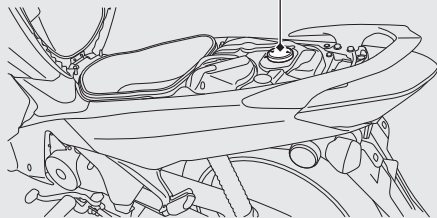
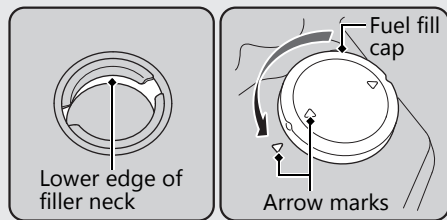

Do not fill with fuel above the lower edge of the filler neck.

Refuelling *(Continued)*

Closing the Fuel Fill Cap

- ① Install and tighten the fuel fill cap firmly by turning it clockwise.
 - ▶ Make sure that the arrow marks on the fuel fill cap and fuel tank is aligned.
- ② Close the seat.

WARNING

Petrol is highly flammable and explosive. You can be burned or seriously injured when handling fuel.

- Stop the engine, and keep heat, sparks, and flame away.
- Handle fuel only outdoors.
- Wipe up spills immediately.

Storage Equipment

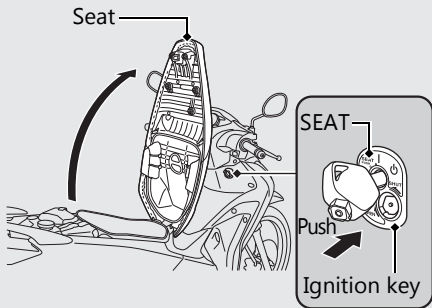

To open the seat

- 1 Turn the handlebar pointed straight ahead.
- 2 Insert the ignition key and turn it to the position of SEAT.
- 3 Push the ignition key and lift up the seat.

To close the seat

Close and push down on the rear of the seat until locks. Make sure that the seat is locked securely to pull it up lightly. Take care not to lock your key in the luggage box under the seat.

Storage Equipment *(Continued)*

Helmet Holder

The helmet holders are located under the seat.

- ▶ Use the helmet holder only when parked.

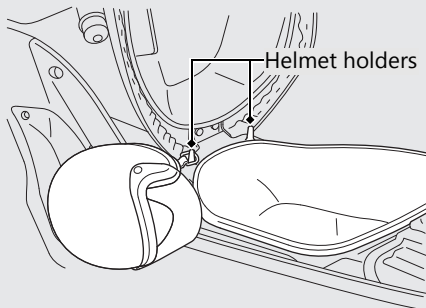

⚠ WARNING

Riding with a helmet attached to the holder can interfere with your ability to safely operate the motorcycle and could lead to a crash in which you can be seriously hurt or killed.

Use the helmet holder only while parked. Do not ride with a helmet secured by the holder.

Luggage Box

Never exceed the maximum weight limit.

Maximum Weight: 10 kg (22 lb)

- ▶ Do not store any items that are flammable or susceptible to heat damage.
- ▶ Do not store valuables or fragile articles.

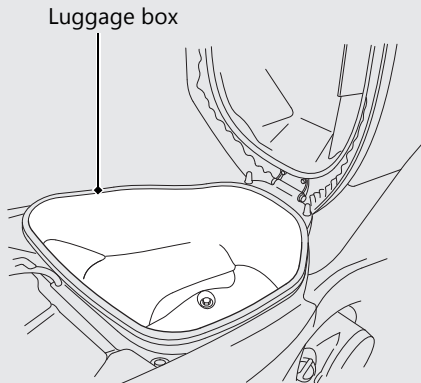

Tool Kit/Document Bag

The tool kit and document bag are in the reverse side of the seat.

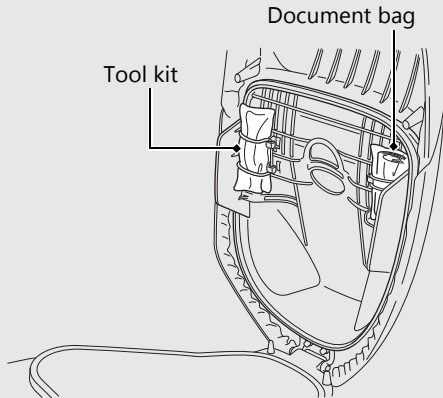

Maintenance

Please read "Importance of Maintenance" and "Maintenance Fundamentals" carefully before attempting any maintenance. Refer to "Specifications" for service data.

Importance of Maintenance	P. 33	Throttle	P. 68
Maintenance Schedule	P. 34	Other Adjustments	P. 69
Maintenance Fundamentals	P. 37	Adjusting the Headlight Aim	P. 69
Tool	P. 48		
Removing & Installing Body Components ...	P. 49		
Battery	P. 49		
Louver	P. 51		
Spark Plug	P. 52		
Engine Oil	P. 54		
Brakes	P. 57		
Side Stand	P. 63		
Drive Chain	P. 64		

Importance of Maintenance

Importance of Maintenance

Keeping your motorcycle well-maintained is absolutely essential to your safety and to protect your investment, obtain maximum performance, avoid breakdowns, and reduce air pollution. Maintenance is the owner's responsibility. Be sure to inspect your motorcycle before each ride, and perform the periodic checks specified in the Maintenance Schedule. ➔ P. 34

WARNING

Improperly maintaining your motorcycle or failing to correct a problem before you ride can cause a crash in which you can be seriously hurt or killed.

Always follow the inspection and maintenance recommendations and schedules in this owner's manual.

Maintenance Safety

Always read the maintenance instructions before you begin each task, and make sure that you have the tools, parts, and skills required. We cannot warn you of every conceivable hazard that can arise in performing maintenance. Only you can decide whether or not you should perform a given task.

Follow these guidelines when performing maintenance.

- Stop the engine and remove the key.
- Place your motorcycle on a firm, level surface using the side stand, centre stand or a maintenance stand to provide support.
- Allow the engine, muffler, brakes, and other high-temperature parts to cool before servicing as you can get burned.
- Run the engine only when instructed, and do so in a well-ventilated area.







Maintenance Schedule

The maintenance schedule specifies the maintenance requirements necessary to ensure safe, dependable performance, and proper emission control.



Maintenance work should be performed in accordance with Honda's standards and specifications by properly trained and equipped technicians. Your dealer meets all of these requirements. Keep an accurate record of maintenance to help ensure that your motorcycle is properly maintained. Make sure that whomever performs the maintenance completes this record.

All scheduled maintenance is considered a normal owner operating cost and will be charged to you by your dealer. Retain all receipts. If you sell the motorcycle, these receipts should be transferred with the motorcycle to the new owner.

Honda recommends that your dealer should road test your motorcycle after each periodic maintenance is carried out.

Items		Pre-ride Check ➔ P. 37	Frequency *1								Annual Check	Regular Replace	Refer to page	
			× 1,000 km	1	6	12	18	24	30	36				
			× 1,000 mi	0.6	4	8	12	16	20	24				
Fuel Line				I	I	I	I	I	I	I	I			-
Fuel Level		I												-
Throttle Operation		I		I	I	I	I	I	I	I	I			68
Air Cleaner *2							R				R			47
Spark Plug				I	R	I	R	I	R					52
Valve Clearance				I	I	I	I	I	I	I				-
Engine Oil		I		R	R	R	R	R	R	R	R	R		54
Engine Oil Strainer Screen						C		C		C				-
Engine Oil Centrifugal filter						C		C		C				-
Engine Idle Speed				I	I	I	I	I	I	I	I			-
Drive Chain		I	Every 500 km (300 mi)					I	L					64

Maintenance Level

-  : Intermediate. We recommend service by your dealer, unless you have the necessary tools and are mechanically skilled. Procedures are provided in an official Honda Shop Manual.
-  : Technical. In the interest of safety, have your motorcycle serviced by your dealer.

Maintenance Legend

- I** : Inspect (clean, adjust, lubricate, or replace, if necessary)
- R** : Replace
- C** : Clean
- L** : Lubricate

Maintenance Schedule

Items	Pre-ride Check P. 37	Frequency *1								Annual Check	Regular Replace	Refer to page	
		× 1,000 km	1	6	12	18	24	30	36				
		× 1,000 mi	0.6	4	8	12	16	20	24				
Brake Fluid*3												2 years	57
Brake Pads Wear (AFS125MCR)													58
Brake Shoes/Pads Wear (AFS125MCS)													58, 61
Brake System (AFS125MCR)													57
Brake System (AFS125MCS)													57
Brakelight Switch													62
Headlight Aim													69
Lights/Horn													-
Clutch System													-
Side Stand													63
Suspension													-
Nuts, Bolts, Fasteners													-
Wheels/Tyres													44
Steering Head Bearings													-

Notes:

*1 : At higher odometer reading, repeat at the frequency interval established here.

*2 : Service more frequently when riding in unusually wet or dusty areas.

*3 : Replacement requires mechanical skill.

Pre-ride Inspection

To ensure safety, it is your responsibility to perform a pre-ride inspection and make sure that any problem you find is corrected. A pre-ride inspection is a must, not only for safety, but because having a breakdown, or even a flat tyre, can be a major inconvenience.

Check the following items before you get on your motorcycle:

- Fuel level - Fill fuel tank when necessary. ➤ P. 27
- Throttle - Check for smooth opening and full closing in all steering positions. ➤ P. 68
- Engine oil level - Add engine oil if necessary. Check for leaks. ➤ P. 54
- Drive chain - Check condition and slack, adjust and lubricate if necessary. ➤ P. 64

- Brakes - Check operation;

AFS125MCS

Front: check brake fluid level and pads wear.

➤ P. 57, 58

Rear: check shoes wear and freeplay, adjust if necessary. ➤ P. 59, 61

AFS125MCR

Front and Rear: check brake fluid level and pads wear. ➤ P. 57, 58

- Lights and horn - Check that lights, indicators and horn function properly.
- Wheels and tyres - Check condition, air pressure and adjust if necessary. ➤ P. 44

Replacing Parts

Always use Honda Genuine Parts or their equivalents to ensure reliability and safety.

WARNING

Installing non-Honda parts may make your motorcycle unsafe and cause a crash in which you can be seriously hurt or killed.

Always use Honda Genuine Parts or equivalents that have been designed and approved for your motorcycle.

Battery

Your motorcycle has a maintenance-free type battery. You do not have to check the battery electrolyte level or add distilled water. Clean the battery terminals if they become dirty or corroded.

Do not remove the battery cap seals. There is no need to remove the cap when charging.

NOTICE

Your battery is a maintenance-free type and can be permanently damaged if the cap strip is removed.

NOTICE

An improperly disposed of battery can be harmful to the environment and human health. Always confirm local regulations for proper battery disposal instruction.

What to do in an emergency

If any of the following occur, immediately see your doctor.

- Electrolyte splashes into your eyes:
 - ▶ Wash your eyes repeatedly with cool water for at least 15 minutes. Using water under pressure can damage your eyes.
- Electrolyte splashes onto your skin:
 - ▶ Remove affected clothing and wash your skin thoroughly using water.
- Electrolyte splashes into your mouth:
 - ▶ Rinse mouth thoroughly with water, and do not swallow.

WARNING

The battery gives off explosive hydrogen gas during normal operation.

A spark or flame can cause the battery to explode with enough force to kill or seriously hurt you.

Wear protective clothing and a face shield, or have a skilled mechanic do the battery servicing.

Cleaning the Battery Terminals

1. Remove the battery.  P. 49
2. If the terminals are starting to corrode and are coated with a white substance, wash with warm water and wipe clean.

Maintenance Fundamentals

3. If the terminals are heavily corroded, clean and polish the terminals with a wire brush or sandpaper. Wear safety glasses.

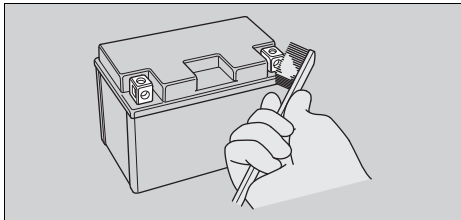

4. After cleaning, reinstall the battery.

The battery has a limited life span. Consult your dealer about when you should replace the battery. Always replace the battery with another maintenance-free battery of the same type.

NOTICE

Installing non-Honda electrical accessories can overload the electrical system, discharging the battery and possibly damaging the system.

Fuses

Fuses protect the electrical circuits on your motorcycle. If something electrical on your motorcycle stops working, check for and replace any blown fuses. ➤ P. 87

Inspecting and Replacing Fuses

Turn the ignition switch to the **O** (Off) position to remove and inspect fuses. If a fuse is blown, replace with a fuse of the same rating. For fuse ratings, see "Specifications." ➤ P. 103

Blown fuse



NOTICE

Replacing a fuse with one that has a higher rating greatly increases the chance of damage to the electrical system.

If a fuse fails repeatedly, you likely have an electrical fault. Have your motorcycle inspected by your dealer.

Engine Oil

Engine oil consumption varies and oil quality deteriorates according to riding conditions and time elapsed.

Check the engine oil level regularly, and add the recommended engine oil if necessary. Dirty oil or old oil should be changed as soon as possible.

Selecting the Engine Oil

For recommended engine oil, see "Specifications." ➤ P. 102

If you use non-Honda engine oil, check the label to make sure that the oil satisfies all of the following standards:

- JASO T 903 standard*¹: MA
- SAE standard*²: 10W-30
- API classification*³: SG or higher

- *1. The JASO T 903 standard is an index for engine oils for 4-stroke motorcycle engines. There are two classes: MA and MB. For example, the following label shows the MA classification.

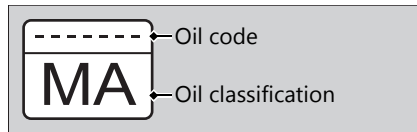

- *2. The SAE standard grades oils by their viscosity.
- *3. The API classification specifies the quality and performance rating of engine oils. Use SG or higher oils, excluding oils marked as "Energy Conserving" or "Resource Conserving" on the circular API service symbol.

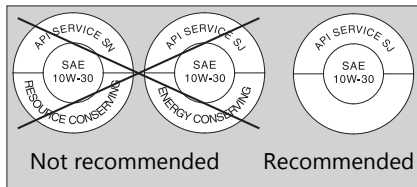

Maintenance Fundamentals

Brake Fluid

Do not add or replace brake fluid, except in an emergency. Use only fresh brake fluid from a sealed container. If you do add fluid, have the brake system serviced by your dealer as soon as possible.

NOTICE

Brake fluid can damage plastic and painted surfaces. Wipe up spills immediately and wash thoroughly.

Recommended brake fluid:

Honda DOT 3 or DOT 4 Brake Fluid or equivalent

Drive Chain

The drive chain must be inspected and lubricated regularly. Inspect the chain more frequently if you often ride on bad roads, ride at high speed, or ride with repeated fast acceleration. ➤ P. 64

If the chain does not move smoothly, makes strange noises, has damaged rollers, has loose pins, or kinks, have the chain inspected by your dealer.

Also inspect the drive sprocket and driven sprocket. If either has worn or damaged teeth, have the sprocket replaced by your dealer.

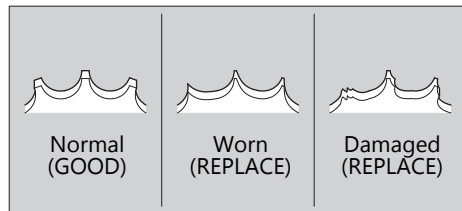

NOTICE

Use of a new chain with worn sprockets will cause rapid chain wear.

Cleaning and Lubricating

After inspecting the slack, clean the chain and sprockets while rotating the rear wheel.

Use a dry cloth with high flash-point solvent.

Use a soft brush if the chain is dirty.

After cleaning, wipe dry and lubricate with the recommended lubricant.

Recommended lubricant:

Drive chain lubricant.

If not available, use SAE 80 or 90 gear oil.

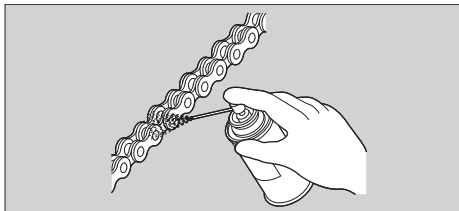

Never use petrol or low flash point solvents for cleaning the drive chain.

A fire or explosion could result.

Avoid getting lubricant on the brakes or tyres.

Avoid applying excess chain lubricant to prevent spray onto your clothes and the motorcycle.

Tyres (Inspecting/Replacing)

Checking the Air Pressure

Visually inspect your tyres and use an air pressure gauge to measure the air pressure at least once a month or any time you think the tyres look low. Always check air pressure when your tyres are cold.

Inspecting for Damage

Inspect the tyres for cuts, slits, or cracks that exposes fabric or cords, or nails or other foreign objects embedded in the side of the tyre or the tread. Also inspect for any unusual bumps or bulges in the side walls of the tyres.

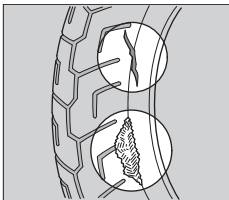

Inspecting for Abnormal Wear

Inspect the tyres for signs of abnormal wear on the contact surface.

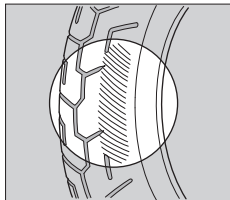

Inspecting Tread Depth

Inspect the tread wear indicators. If they become visible, replace the tyres immediately.

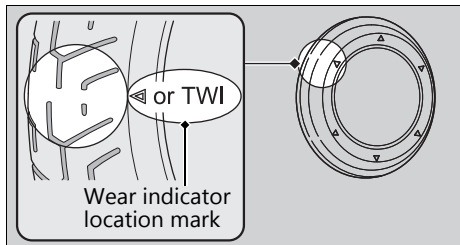

⚠️ WARNING

Riding on tyres that are excessively worn or improperly inflated can cause a crash in which you can be seriously hurt or killed.

Follow all instructions in this owner's manual regarding tyre inflation and maintenance.

Maintenance Fundamentals

Have your tyres replaced by your dealer. For recommended tyres and air pressure, see "Specifications." ➔ P. 102

Follow these guidelines whenever you replace tyres.

- Use the recommended tyres or equivalents of the same size, construction, speed rating, and load range.
- Do not install a tube inside a tubeless tyre on this motorcycle. Excessive heat build-up can cause the tube to burst.
- Use only tubeless tyres on this motorcycle. The rims are designed for tubeless tyres, and during hard acceleration or braking, a tube-type tyre could slip on the rim and cause the tyre to rapidly deflate.

WARNING

Installing improper tyres on your motorcycle can adversely affect handling and stability, and can cause a crash in which you can be seriously hurt or killed.

Always use the size and type of tyres recommended in this owner's manual.

Air Cleaner

This motorcycle is equipped with a viscous type air cleaner element.

Air blow cleaning or any other cleaning can degrade the viscous element performance and cause the intake of dust.

Do not perform the maintenance.
Should be serviced by your dealer.

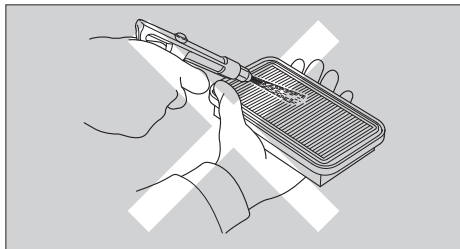

Tool

The tool kit is stored in the reverse side of the seat. ➔ P. 31

You can perform some roadside repairs, minor adjustments and parts replacement with the provided tools.

- Spark plug wrench
- Standard/Phillips screwdriver
- Screwdriver handle
- 10 × 14 mm Open end wrench

Battery

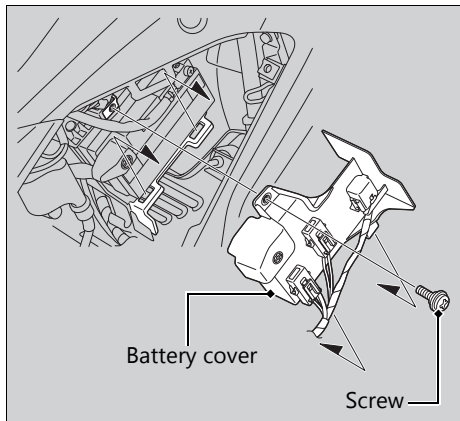

Removal

Make sure the ignition switch is in the \bigcirc (Off) position.

1. Remove the right louver. ➤ P. 51
2. Remove the battery cover by removing the screw.

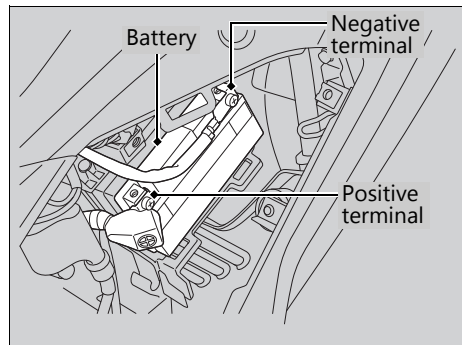

3. Disconnect the negative \ominus terminal from the battery.

4. Disconnect the positive ⊕ terminal from the battery.
5. Remove the battery taking care not to drop the terminal nuts.

Installation

Install the parts in the reverse order of removal. Always connect the positive ⊕ terminal first. Make sure that bolts and nuts are tight.

For proper handling of the battery, see "Maintenance Fundamentals." ➤ P. 38
"Battery Goes Dead." ➤ P. 81

Louver

Removal

Remove the louver by removing the screws and release the tabs from slots.

Installation

Install the parts in the reverse order of removal.

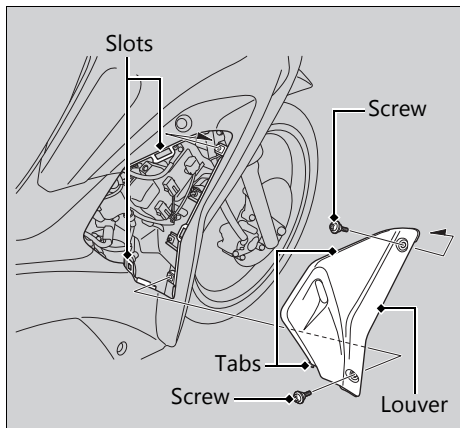

Checking Spark Plug

For the recommended spark plug, see "Specifications." ➔ P. 102

Use only the recommended type of spark plug in the recommended heat range.

NOTICE

Using a spark plug with an improper heat range can cause engine damage.

1. Remove the right louver. ➔ P. 51
2. Disconnect the spark plug cap from the spark plug.
3. Clean any dirt from around the spark plug base.
4. Remove the spark plug using provided spark plug wrench. ➔ P. 48

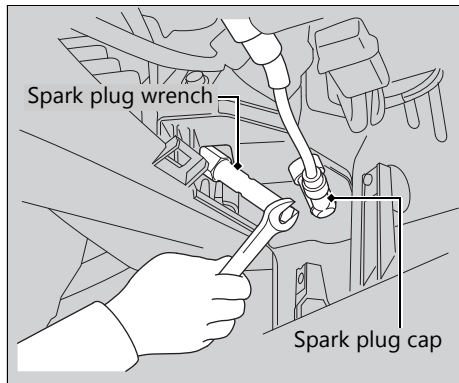

5. Inspect the electrodes and centre porcelain for deposits, erosion or carbon fouling.
 - ▶ If the erosion or deposit is heavy, replace the plug.
 - ▶ Clean a carbon or wet-fouled plug with a plug cleaner, otherwise use a wire brush.

6. Check the spark plug gap using a wire-type feeler gauge.
 ► If adjustment is necessary, bend the side electrode carefully.

The gap should be:

0.8 to 0.9 mm (0.03 to 0.04 in)

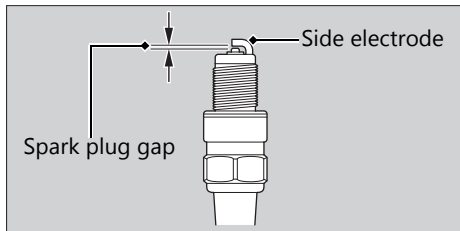

7. Make sure the plug washer is in good condition.
 8. Install the spark plug. With the plug washer attached, thread the spark plug in by hand to prevent cross-threading.

9. Tighten the spark plug:
- If the old plug is good:
 - 1/8 turn after it seats
 - If installing a new plug, tighten it twice to prevent loosening:
 - a) First, tighten the plug:
 - NGK: 1/2 turn after it seats.
 - DENSO: 3/4 turn after it seats.
 - b) Then loosen the plug.
 - c) Next, tighten the plug again:
 - 1/8 turn after it seats

NOTICE

An improperly tightened spark plug can damage the engine. If a plug is too loose, a piston may be damaged. If a plug is too tight, the threads may be damaged.

10. Install the parts in the reverse order of removal.
 ► When reinstalling the spark plug cap, take care to avoid pinching any cables or wires.

Checking the Engine Oil

1. If the engine is cold, idle the engine for 3 to 5 minutes.
2. Turn the ignition switch to the **O** (Off) position and wait for 2 to 3 minutes.
3. Place your motorcycle on its centre stand on a firm, level surface.
4. Remove the oil fill cap/dipstick and wipe it clean.
5. Insert the oil fill cap/dipstick until it seats, but don't screw it in.
6. Check that the oil level is between the upper level and lower level marks on the oil fill cap/dipstick.
7. Securely install the oil fill cap/dipstick.

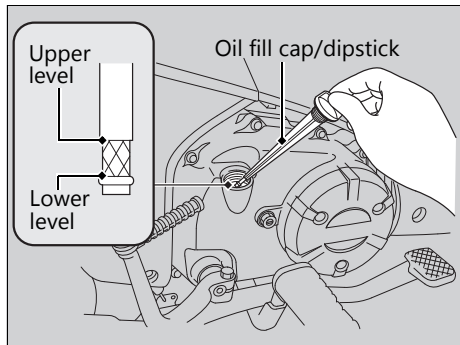

Adding Engine Oil

If the engine oil is below or near the lower level mark, add the recommended engine oil.

► P. 41, 102

1. Remove the oil fill cap/dipstick.
Add the recommended oil until it reaches the upper level mark.
 - Place your motorcycle on its centre stand on a firm, level surface when checking the oil level.
 - Do not overfill above the upper level mark.
 - Make sure no foreign objects enter the oil filler opening.
 - Wipe up any spills immediately.
2. Securely reinstall the oil fill cap/dipstick.

NOTICE

Overfilling with oil or operating with insufficient oil can cause damage to your engine. Do not mix different brands and grades of oil. They may affect lubrication and clutch operation.

For the recommended oil and oil selection guidelines, see “Maintenance Fundamentals.”

► P. 41

Changing Engine Oil

Changing the oil requires special tools. We recommend that you have your motorcycle serviced by your dealer.

1. If the engine is cold, idle the engine for 3 to 5 minutes.
2. Turn the ignition switch to the **O** (Off) position and wait for 2 to 3 minutes.

Engine Oil ► Changing Engine Oil

3. Place your motorcycle on its centre stand on a firm, level surface.
4. Place a drain pan under the drain bolt.
5. Remove the oil fill cap/dipstick, drain bolt and sealing washer to drain the oil.
► Discard the oil at an approved recycling centre.

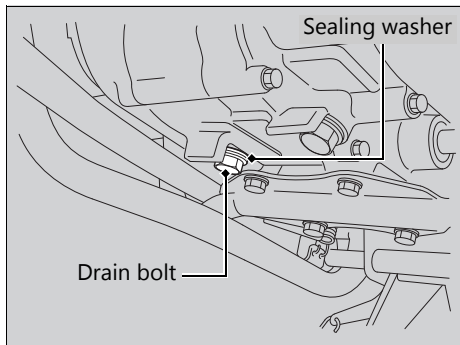

6. Install a new sealing washer onto the drain bolt. Tighten the drain bolt.

Torque: 24 N·m (2.4 kgf·m, 18 lbf·ft)

7. Fill the crankcase with the recommended oil (► P. 41, 102) and install the oil fill cap/dipstick.

Required oil

When changing oil:

0.7 litres (0.7 US qt, 0.6 Imp qt)

8. Check the oil level. ► P. 54
9. Check that there are no oil leaks.

Checking Brake Fluid

1. Place your motorcycle in an upright position on a firm, level surface.
2. **Front** Check that the brake fluid reservoir is horizontal and that the fluid level is above the LOWER level mark.

AFS125MCR

- Rear** Check that the brake fluid reservoir is horizontal and that the fluid level is between the LOWER level and UPPER level marks.

AFS125MCS

If the brake fluid level in the reservoir is below the LOWER level mark or the brake lever freeplay becomes excessive, inspect the brake pads for wear.

AFS125MCR

If the brake fluid level in either reservoir is below the LOWER level mark or the brake lever and pedal freeplay becomes excessive, inspect the brake pads for wear.

If the brake pads are not worn, you most likely have a leak. Have your motorcycle inspected by your dealer.

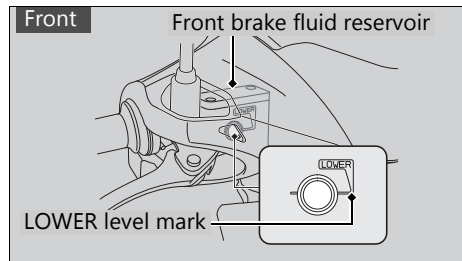

AFS125MCR

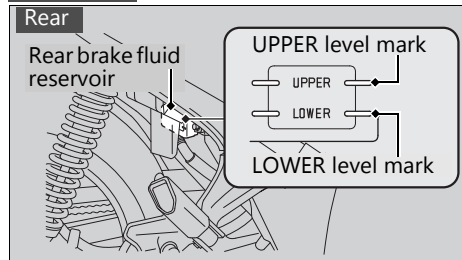

Inspecting the Brake Pads

Check the condition of the brake pad wear indicators.

The pads need to be replaced if a brake pad is worn to the indicator.

- 1. Front** Inspect the brake pads from below the brake caliper.
- 2. AFS125MCR**
Rear Inspect the brake pads from the rear right of the motorcycle.

If necessary have the pads replaced by your dealer.

Always replace both left and right brake pads at the same time.

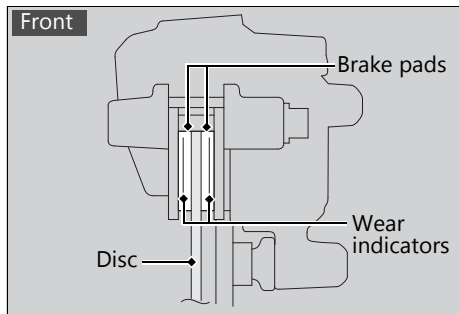

AFS125MCR

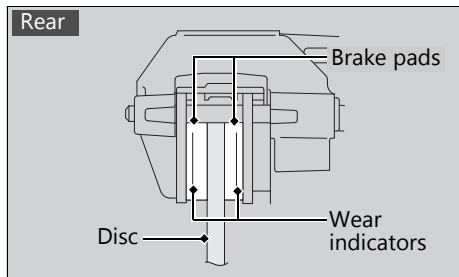

Inspecting the Rear Brake Pedal Freeplay

AFS125MCS

1. Place your motorcycle on its centre stand on a firm, level surface.
2. Measure the distance the rear brake pedal moves before the brake takes hold.

Freeplay at the tip of the brake pedal:
20 to 30 mm (0.8 to 1.2 in)

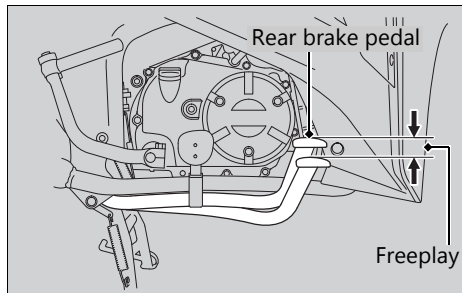

Make sure the brake rod, brake arm, spring and fastener are in good condition.

Adjusting the Rear Brake Pedal Freeplay

AFS125MCS

Make sure the cut-out on the adjusting nut is seated on the brake arm pin when adjusting the freeplay.

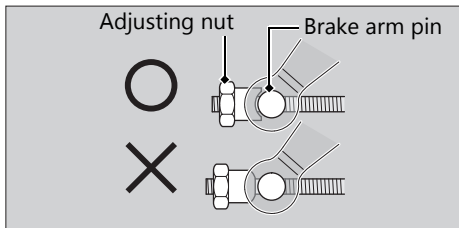

If proper adjustment cannot be obtained by this method, see your dealer.

Brakes ► Adjusting the Rear Brake Pedal Freeplay

1. Adjust by turning the rear brake adjusting nut a half-turn at a time.

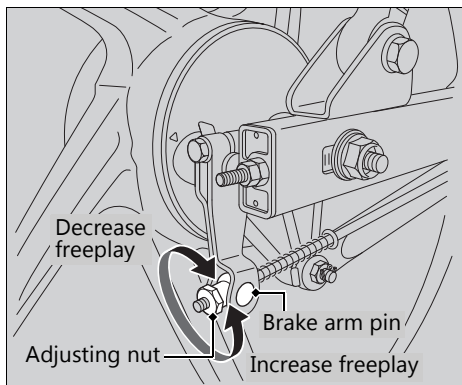

2. Apply the brake several times and check for free wheel rotation after the brake pedal is released.

3. Push the brake arm to confirm that there is a gap between the rear brake adjusting nut and brake arm pin.

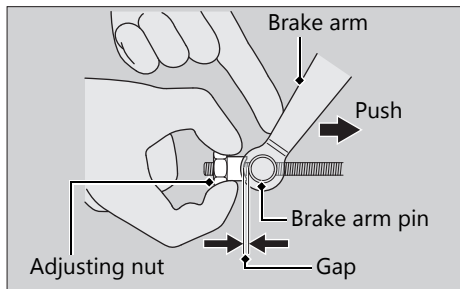

After adjustment, confirm the freeplay of the brake pedal.

Make sure the brake rod, brake arm, spring and fastener are in good condition.

NOTICE

Do not turn the adjuster beyond its natural limits.

Inspecting the Rear Brake Shoe Wear

AFS125MCS

The rear brake is equipped with a brake wear indicator.

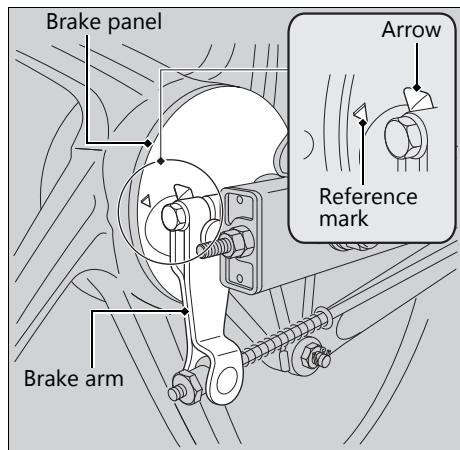

When the brake is applied, an arrow attached to the brake arm moves toward a reference mark on the brake panel. If the arrow aligns with the reference mark on full application of the brake, the brake shoes must be replaced. See your dealer for this service.

When the brake service is necessary, see your dealer. Use only Honda Genuine Parts or its equivalent.

Adjusting the Brakelight Switch

Check the operation of the brakelight switch. Hold the brakelight switch and turn the adjusting nut in the direction A if the switch operates too late, or turn the nut in the direction B if the switch operates too soon.

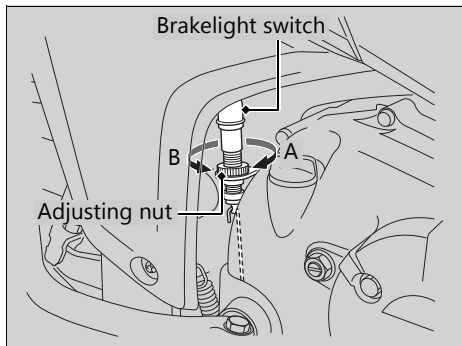

Checking the Side Stand

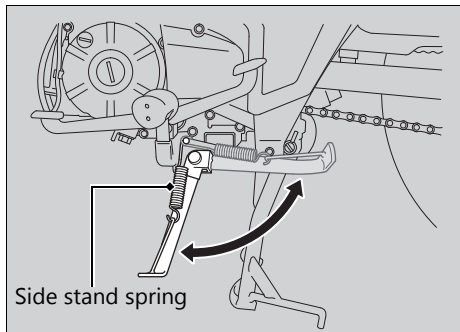

1. Check that the side stand operates smoothly. If the side stand is stiff or squeaky, clean the pivot area and lubricate the pivot bolt with clean grease.
2. Check the spring for damage or loss of tension.

Inspecting the Drive Chain Slack

Check the drive chain slack at several points along the chain. If the slack is not constant at all points, some links may be kinked and binding.

Have the chain inspected by your dealer.

1. Shift the transmission to Neutral.
Stop the engine.
2. Place your motorcycle on its centre stand on a firm, level surface.
3. Check the slack in the lower half of the drive chain midway between the sprockets.

Drive chain slack:

25 to 35 mm (1.0 to 1.4 in)

- ▶ Do not ride your motorcycle if the slack exceeds 50 mm (2.0 in).

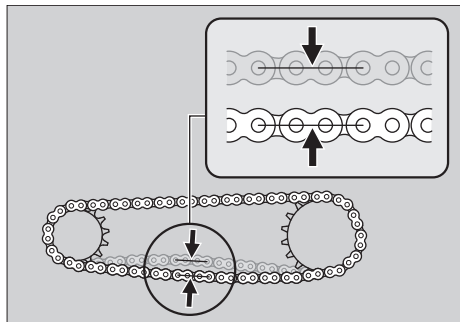

4. Rotate the rear wheel and check that the chain moves smoothly.
5. Inspect the sprockets. ➤ P. 42
6. Clean and lubricate the drive chain. ➤ P. 43

Adjusting the Drive Chain Slack

Adjusting the chain requires special tools. Have the drive chain slack adjusted by your dealer.

1. Shift the transmission to Neutral. Stop the engine.
2. Place your motorcycle on its centre stand on a firm, level surface.
3. Loosen the rear axle nut.
4. Loosen the lock nuts on both sides of the swingarm.

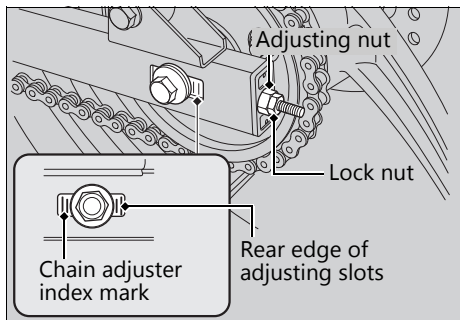
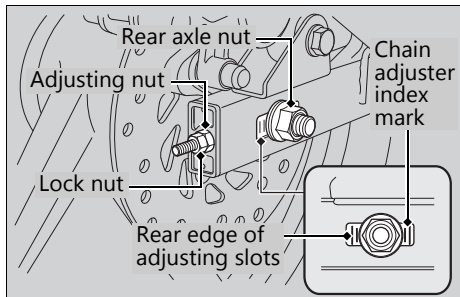

Drive Chain ► Adjusting the Drive Chain Slack

5. Turn both adjusting nuts an equal number of turns until the correct drive chain slack is obtained. Turn the adjusting nuts clockwise to tighten the chain. Turn the adjusting nuts counterclockwise and push the rear wheel toward the front to provide more slack.
Adjust the slack at a point midway between the drive sprocket and the driven sprocket.
Check the drive chain slack. ➤ P. 64
6. Check rear axle alignment by making sure the chain adjuster index marks aligns with the rear edge of the adjusting slots on both sides of the swingarm.
Both marks should correspond. If the axle is misaligned, turn the right or left adjusting nuts until the marks are aligned and recheck chain slack.

7. Tighten the rear axle nut.

Torque: 59 N·m (6.0 kgf·m, 44 lbf·ft)

8. Tighten the drive chain adjusting nuts lightly, then hold the adjusting nuts and tighten the lock nuts.
9. Recheck drive chain slack.
10. **AFS125MCS**
Rear brake pedal freeplay is affected when repositioning the rear wheel to adjust drive chain slack. Check rear brake pedal freeplay and adjust as necessary.
➤ P. 59

If a torque wrench was not used for installation, see your dealer as soon as possible to verify proper assembly. Improper assembly may lead to loss of braking capacity.

Checking the Drive Chain Wear

If the drive chain slack is excessive when the rear axle is moved to the furthest limit of adjustment, the drive chain is worn and must be replaced.

Chain:

RK420EL

KMC420JB

If necessary have the drive chain replaced by your dealer.

Checking the Throttle

With the engine off, check that the throttle rotates smoothly from fully closed to fully open in all steering positions and throttle freeplay is correct. If the throttle does not move smoothly, close automatically, or if the cable is damaged, have the motorcycle inspected by your dealer.

Freeplay at the throttle grip flange:

2 to 6 mm (0.1 to 0.2 in).

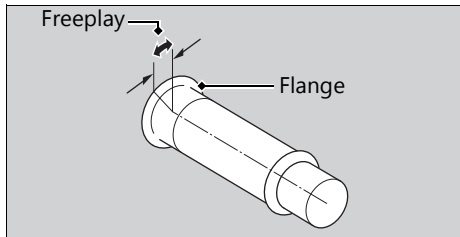

Adjusting the Headlight Aim

You can adjust vertical aim of the headlight for proper alignment. Loosen the adjusting bolt and move the headlight up or down as necessary.

Tighten the adjusting bolt after adjustment. Obey local laws and regulations.

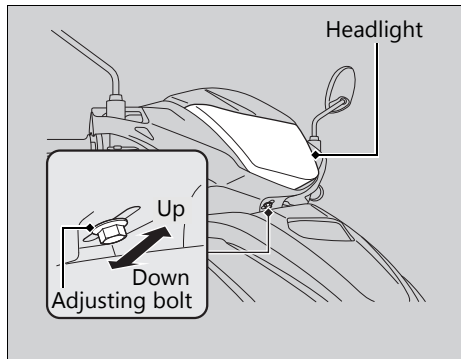

Troubleshooting

Engine Will Not Start	P. 71
Warning Indicators On or Flashing	P. 72
PGM-FI (Programmed Fuel Injection)	
Malfunction Indicator Lamp (MIL)	P. 72
Tyre Puncture	P. 73
Emergency Repair Using a Tyre Repair Kit....	P. 73
Electrical Trouble	P. 81
Battery Goes Dead.....	P. 81
Burned-out Light Bulb	P. 81
Blown Fuse.....	P. 87
Unstable Engine Operation Occurs	
Intermittently	P. 89

Starter Motor Operates But Engine Does Not Start

Check the following items:

- Check the correct engine starting sequence.
➤ P. 23
- Check that there is petrol in the fuel tank.
- Check if the PGM-FI malfunction indicator lamp (MIL) is on.
 - ▶ If the indicator lamp is on, contact your dealer as soon as possible.

Starter Motor Does Not Operate

Check the following items:

- Check the correct engine starting sequence.
➤ P. 23
 - Check for a blown fuse. ➤ P. 87
 - Check for a loose battery connection (➤ P. 49) or battery terminal corrosion (➤ P. 38).
 - Check the condition of the battery. ➤ P. 81
- If the problem continues, have your motorcycle inspected by your dealer.

PGM-FI (Programmed Fuel Injection) Malfunction Indicator Lamp (MIL)

If the indicator comes on while riding, you may have a serious problem with the PGM-FI system. Reduce speed and have your motorcycle inspected by your dealer as soon as possible.

Tyre Puncture

Repairing a puncture or removing a wheel requires special tools and technical expertise. We recommend you have this type of service performed by your dealer.

After an emergency repair, always have the tyre inspected/replaced by your dealer.

Emergency Repair Using a Tyre Repair Kit

If your tyre has a minor puncture, you can make an emergency repair using a tubeless tyre repair kit.

Follow the instructions provided with the emergency tyre repair kit.

Riding your motorcycle with a temporary tyre repair is very risky. Do not exceed 50 km/h (30 mph). Have the tyre replaced by your dealer as soon as possible.

WARNING

Riding your motorcycle with a temporary tyre repair can be risky. If the temporary repair fails, you can crash and be seriously injured or killed.

If you must ride with a temporary tyre repair, ride slowly and carefully and do not exceed 50 km/h (30 mph) until the tyre is replaced.

Removing Wheels

Follow these procedures if you need to remove a wheel in order to repair a puncture.

Front Wheel

Removal

1. Place your motorcycle on its centre stand on a firm, level surface.
2. Support your motorcycle securely and raise the front wheel off the ground using a maintenance stand or a hoist.
3. Remove the speedometer cable by pushing the tab.
4. Remove the front axle nut.
5. Remove the front axle shaft, front wheel, speedometer gearbox and side collar.
 - Avoid getting grease, oil, or dirt on the disc or pad surfaces.
 - Do not pull the brake lever while the front wheel is removed.

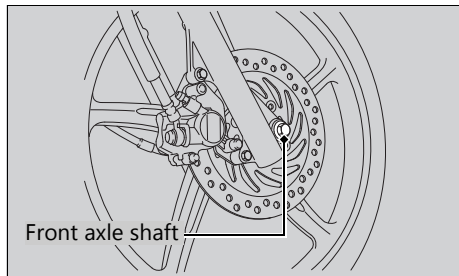
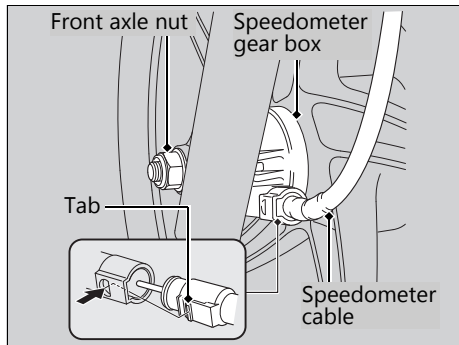

Installation

1. Attach the side collar and speedometer gearbox to the wheel.
2. Position the wheel between the fork legs and insert the front axle shaft from the right side, through the right fork leg and wheel hub.

NOTICE

When installing a wheel or caliper into original position, carefully fit the brake disc between the pads to avoid scratching them.

3. Make sure that the lug on the left fork leg is located in the slot of the speedometer gearbox.
4. Tighten the axle nut.

Torque: 59 N·m (6.0 kgf·m, 44 lbf·ft)

5. After installing the wheel, apply the brake lever several times, then check if the wheel rotates freely. Recheck the wheel if the brake drags or if the wheel does not rotate freely.
6. Install the speedometer cable securely.

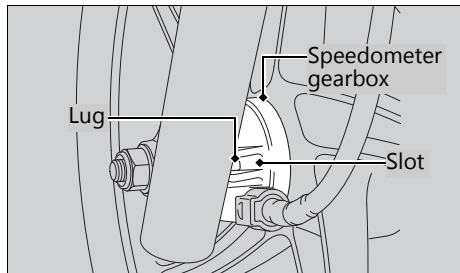

If a torque wrench was not used for installation, see your dealer as soon as possible to verify proper assembly.

Improper assembly may lead to loss of braking capacity.

Rear Wheel

AFS125MCR

Removal

1. Support your motorcycle securely and raise the rear wheel off the ground using the centre stand or a hoist.
2. Loosen the rear axle nut, lock nuts and turn the adjusting nuts so the rear wheel can be moved all the way forward for maximum drive chain slack.
3. Remove the rear axle nut.

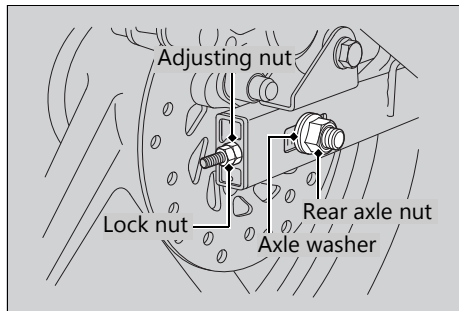

4. Remove the drive chain from the driven sprocket by pushing the rear wheel forward.

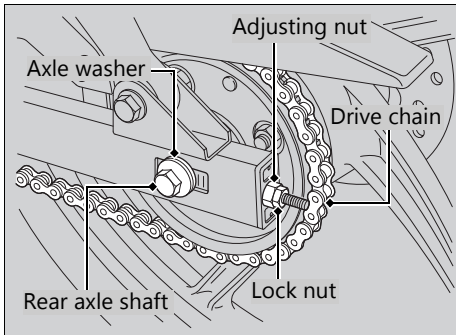

5. Remove the rear axle shaft, axle washers, side collars and rear wheel.
 - Support the brake caliper assembly so that it doesn't hang from the brake hose. Do not twist the brake hose.
 - Avoid getting grease, oil, or dirt on the disc or pad surfaces.
 - Do not push the brake pedal while the brake caliper is removed.

Installation

1. To install the rear wheel, reverse the removal procedure.
 - Take care to prevent the brake caliper from scratching the wheel during installation.

NOTICE

When installing a wheel or caliper into original position, carefully fit the brake disc between the pads to avoid scratching them.

2. Make sure that the slot on the brake caliper bracket aligns with the lug on the swingarm.

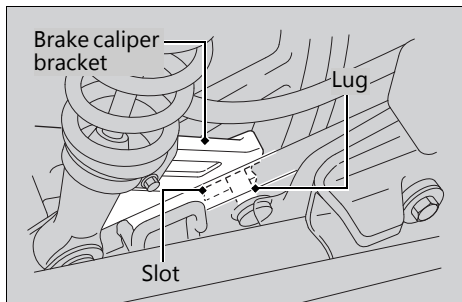

3. Adjust the drive chain slack. ► P. 65
4. Install and tighten the rear axle nut.

Torque: 59 N·m (6.0 kgf·m, 44 lbf·ft).

5. After installing the wheel, apply the brake pedal several times, then recheck that the wheel rotates freely. Recheck the wheel if the brake drags or if the wheel does not rotate freely.

If a torque wrench was not used for installation, see your dealer as soon as possible to verify proper assembly. Improper assembly may lead to loss of braking capacity.

Rear Wheel

AFS125MCS

Removal

1. Support your motorcycle securely and raise the rear wheel off the ground using a centre stand or a hoist.
2. Remove the rear brake adjusting nut.
3. Disconnect the brake rod from the brake arm.
4. Disconnect the brake stopper arm from the brake panel by removing the cotter pin, brake stopper arm nut, washer and rubber grommet.

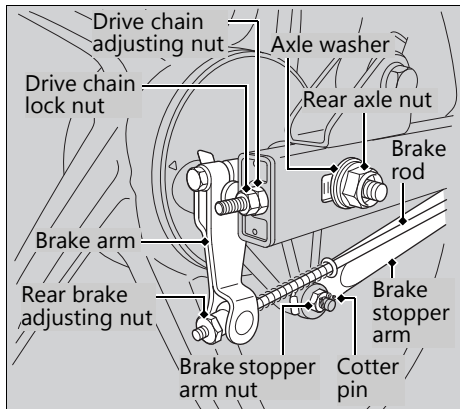

5. Loosen the drive chain lock nuts and drive chain adjusting nuts on both sides of the swingarm.
6. Remove the rear axle nut while holding the rear axle shaft at the other rear with a wrench.

Tyre Puncture ► Removing Wheels

7. Remove the drive chain from the driven sprocket by pushing the rear wheel forward.
8. Remove the rear axle shaft, axle washers, side collars and rear wheel from the swingarm.

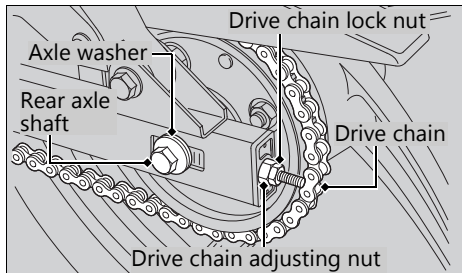

Installation

1. To install the rear wheel, reverse the removal procedure.
2. Tighten the rear axle nut.

Torque: 59 N·m (6.0 kgf·m, 44 lbf·ft)

3. Tighten the brake stopper arm nut.

Torque: 22 N·m (2.2 kgf·m, 16 lbf·ft)

4. Adjust the drive chain slack. ► P. 65
5. Adjust the rear brake pedal freeplay. ► P. 59
6. After installing the wheel, apply the brake pedal several times, then check if the wheel rotates freely. Recheck the wheel if the brake drags or if the wheel does not rotate freely.

If a torque wrench was not used for installation, see your dealer as soon as possible to verify proper assembly.

Improper assembly may lead to loss of braking capacity.

A used cotter pin may not effectively secure a fastener. Always replace a used cotter pin with a new one.

Battery Goes Dead

Charge the battery using a motorcycle battery charger.

Remove the battery from the motorcycle before charging.

Do not use an automobile-type battery charger, as these can overheat a motorcycle battery and cause permanent damage.



If the battery does not recover after recharging, contact your dealer.

NOTICE

Jump starting using an automobile battery can damage your motorcycle's electrical system and is not recommended.

Burned-out Light Bulb

Follow the procedure below to replace a burned-out light bulb.

Turn the ignition switch to the  (Off) or  (Lock) position.

Allow the bulb to cool before replacing it.

Do not use bulbs other than those specified.

Check the replacement bulb for correct operation before riding.

For the light bulb wattage, see "Specifications." ➔ P. 103

Headlight

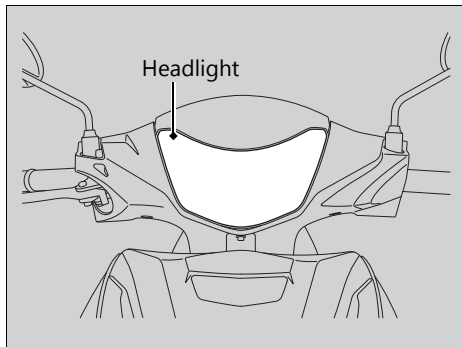

The headlight uses several LEDs. If there is an LED which is not turned on, see your dealer for servicing.

Position Light Bulb

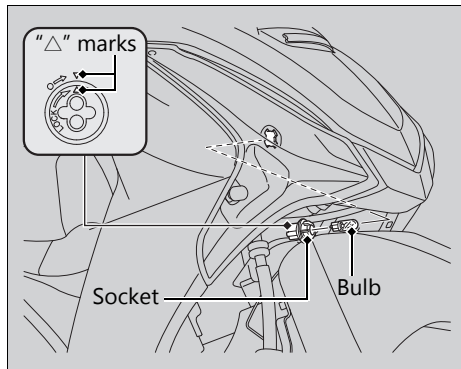

1. Turn the socket counterclockwise, and pull it out.
2. Pull out the bulb without turning it.
3. Install a new bulb and parts in the reverse order of removal.

- Install the socket by turning it clockwise. Make sure that the "△" marks on the socket and position light housing are aligned.

Brakelight/Taillight/License Plate Light Bulb

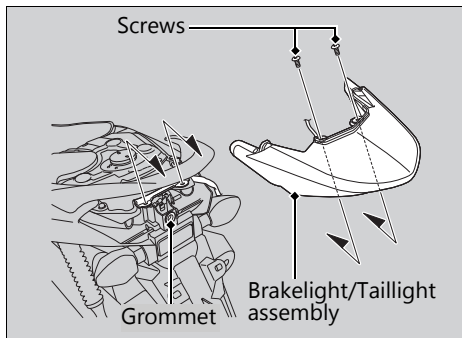

1. Open the seat. ► P. 29
2. Remove the brakelight/taillight assembly by removing the screws.
3. Turn the socket counterclockwise, and pull it out.

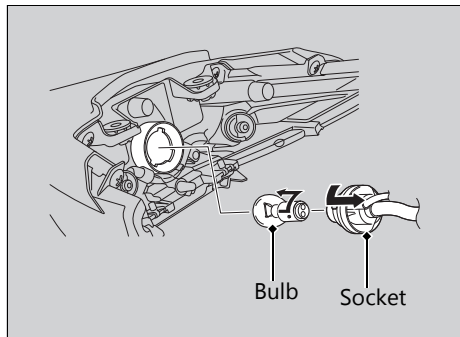

4. Slightly press the bulb and turn it counterclockwise.
5. Install a new bulb in the reverse order of removal.
6. Install the remaining parts in the reverse order of removal.
7. Close the seat.

Front Turn Signal Bulb

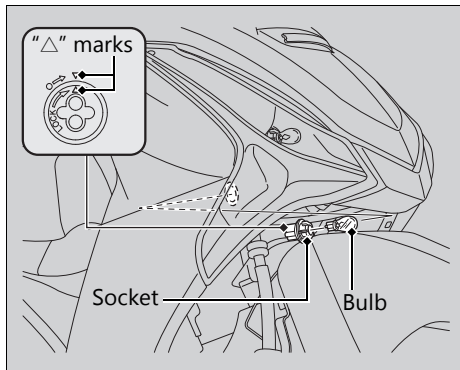

1. Turn the socket counterclockwise, and pull it out.
2. Pull out the bulb without turning it.
3. Install a new bulb and parts in the reverse order of removal.

- Install the socket by turning it clockwise. Make sure that the "△" marks on the socket and front turn signal housing are aligned.
- Use only the amber bulb.

Rear Turn Signal Bulb

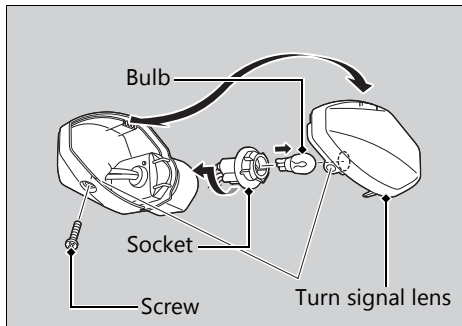

1. Remove the turn signal lens by removing the screw.
2. Turn the socket counterclockwise, and remove it.

3. Pull out the bulb without turning it.
4. Install a new bulb and parts in the reverse order of removal.
 - Use only the amber bulb.

Blown Fuse

Before handling fuses, see "Inspecting and Replacing Fuses." ► P. 40

Fuse Box Fuses

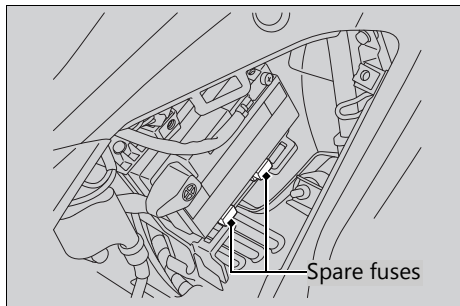
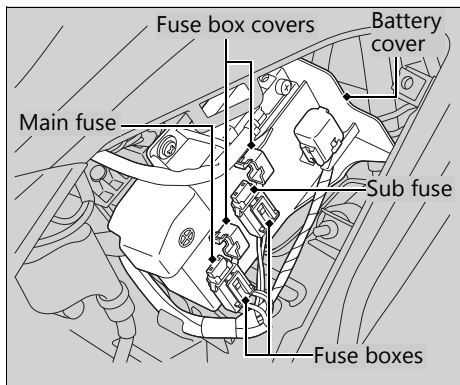

1. Remove the right louver. ► P. 51
2. Open the fuse box covers.
3. Remove the battery cover. ► P. 49
4. Pull out the fuses one by one to check for a blown fuse. Always replace a blown fuse with a spare fuse of the same rating.
 - Spare fuses are located under the battery box.

Electrical Trouble ► Blown Fuse

5. Reinstall the battery cover.
6. Close the fuse box covers.
7. Reinstall the right louver.

NOTICE

If a fuse fails repeatedly, you likely have an electrical problem. Have your motorcycle inspected by your dealer.

Unstable Engine Operation Occurs Intermittently

If the fuel pump filter is clogged, unstable engine operation will occur intermittently while riding.

Even if this symptom occurs, you can continue to ride your motorcycle.

If unstable engine operation occurs even if sufficient fuel is available, have your motorcycle inspected by your dealer as soon as possible.

Information

Keys.....	P. 91
Instruments, Controls, & Other Features ...	P. 92
Caring for Your Motorcycle.....	P. 93
Storing Your Motorcycle	P. 96
Transporting Your Motorcycle.....	P. 96
You & the Environment.....	P. 97
Serial Numbers	P. 98
Fuels Containing Alcohol.....	P. 99
Catalytic Converter.....	P. 100

Keys

Ignition Key

Be sure to record the key number provided with the key number plate. Store the spare key and key number in a safe location.

To make a duplicate, take the spare key or the key number to your dealer.

If you lose all ignition keys and the key number, the ignition switch assembly will probably have to be removed by your dealer to determine the key number.

A metal key holder may cause damage to the area surrounding the ignition switch.

Instruments, Controls, & Other Features

Ignition Switch

Leaving the ignition switch in the **I** (On) position with the engine stopped will drain the battery.

Do not turn the key while riding.

Odometer

The odometer returns to 0 when the read-out exceeds 99,999.9.

Document Bag

The owner's manual, registration, and insurance information can be stored in the plastic document bag located reverse side of the seat.

➤ P. 31

Caring for Your Motorcycle

Frequent cleaning and polishing is important to ensure the long life of your Honda. A clean motorcycle makes it easier to spot potential problems.

In particular, seawater and salts used to prevent ice on roads promote the formation of corrosion. Always wash your motorcycle thoroughly after riding on coastal or treated roads.

Washing

Allow the engine, muffler, brakes, and other high-temperature parts to cool before washing.

1. Rinse your motorcycle thoroughly using a low pressure garden hose to remove loose dirt.
2. If necessary, use a sponge or a soft towel with mild cleaner to remove road grime.
 - ▶ Clean the headlight lens, panels, and other plastic components with extra care to avoid scratching them. Avoid directing water into the air cleaner, muffler, and electrical parts.

3. Thoroughly rinse your motorcycle with plenty of clean water and dry with a soft, clean cloth.
4. After the motorcycle dries, lubricate any moving parts.
 - ▶ Make sure that no lubricant spills onto the brakes or tyres. Brake discs, pads, drum or shoes contaminated with oil will suffer greatly reduced braking effectiveness and can cause a crash.
5. Lubricate the drive chain immediately after washing and drying the motorcycle.
6. Apply a coat of wax to prevent corrosion.
 - ▶ Avoid products that contain harsh detergents or chemical solvents. These can damage the metal, paint, and plastic on your motorcycle.
 - ▶ Keep the wax clear of the tyres and brakes.
 - ▶ If your motorcycle has any mat painted parts, do not apply a coat of wax to the mat painted surface.

Caring for Your Motorcycle

Washing Precautions

Follow these guidelines when washing:

- Do not use high-pressure washers:
 - ▶ High-pressure water cleaners can damage moving parts and electrical parts, rendering them inoperable.
 - ▶ Water in the intake can be drawn into the throttle body and/or enter the air cleaner.
- Do not direct water at the muffler:
 - ▶ Water in the muffler can prevent starting and causes rust in the muffler.
- Dry the brakes:
 - ▶ Water adversely affects braking effectiveness. After washing, apply the brakes intermittently at low speed to help dry them.
- Do not direct water under the seat:
 - ▶ Water in the under seat compartment can damage your documents and other belongings.
- Do not direct water at the air cleaner:
 - ▶ Water in the air cleaner can prevent the engine from starting.

- Do not direct water near the headlight:
 - ▶ The headlights' inside lens may fog temporarily after washing or while riding in the rain. This does not impact the headlight function.
However, if you see a large amount of water or ice accumulated inside the lens(es), have your vehicle inspected by your dealer.
- Do not use wax or polishing compounds on mat painted surface:
 - ▶ Use a soft cloth or sponge, plenty of water, and a mild detergent to clean mat painted surfaces. Dry with a soft clean cloth.

Aluminium Components

Aluminium will corrode from contact with dirt, mud, or road salt. Clean aluminium parts regularly and follow these guidelines to avoid scratches:

- Do not use stiff brushes, steel wool, or cleaners containing abrasives.
- Avoid riding over or scraping against curbs.

Panels

Follow these guidelines to prevent scratches and blemishes:

- Wash gently using a soft sponge and plenty of water.
- To remove stubborn stains, use diluted detergent and rinse thoroughly with plenty of water.
- Avoid getting petrol, brake fluid, or detergents on the instruments, panels, or headlight.

Exhaust Pipe and Muffler

When the exhaust pipe and muffler are painted, do not use a commercially available abrasive kitchen cleaning compound. Use a neutral detergent to clean the painted surface on the exhaust pipe and muffler. If you are not sure if your exhaust pipe and muffler are painted, contact your dealer.

Storing Your Motorcycle

If you store your motorcycle outdoors, you should consider using a full-body motorcycle cover.

If you won't be riding for an extended period, follow these guidelines:

- Wash your motorcycle and wax all painted surfaces (except mat painted surfaces). Coat chrome pieces with rust-inhibiting oil.
- Lubricate the drive chain. ➤ P. 43
- Place your motorcycle on its centre stand and position a block so that both tyres are off the ground.
- After rain, remove the body cover and allow the motorcycle to dry.
- Remove the battery (➤ P. 49) to prevent discharge. Fully charge the battery and then place it in a shaded, well-ventilated area.
 - ▶ If you leave the battery in place, disconnect the negative ⊖ terminal to prevent discharge.

After removing your motorcycle from storage, inspect all maintenance items required by the Maintenance Schedule.

Transporting Your Motorcycle

If your motorcycle needs to be transported, it should be carried on a motorcycle trailer or a flatbed truck or trailer that has a loading ramp or lifting platform, and motorcycle tie-down straps. Never try to tow your motorcycle with a wheel or wheels on the ground.

NOTICE

Towing your motorcycle can cause serious damage to the transmission.

You & the Environment

Owning and riding a motorcycle can be enjoyable, but you must do your part to protect the environment.

Choose Sensible Cleaners

Use a biodegradable detergent when you wash your motorcycle. Avoid aerosol spray cleaners that contain chlorofluorocarbons (CFCs) which damage the atmosphere's protective ozone layer.

Recycle Wastes

Put oil and other toxic wastes in approved containers and take them to a recycling centre. Call your local or state office of public works or environmental services to find a recycling centre in your area, and to get instructions on how to dispose of non-recyclable wastes. Do not place used engine oil in the trash, or pour it down a

drain or on the ground. Used oil, petrol, and cleaning solvents contain poisons that can hurt refuse workers and contaminate drinking water, lakes, rivers, and oceans.

Serial Numbers

The frame and engine serial numbers uniquely identify your motorcycle and are required in order to register your motorcycle. They may also be required when ordering replacement parts. You should record these numbers and keep them in a safe place.

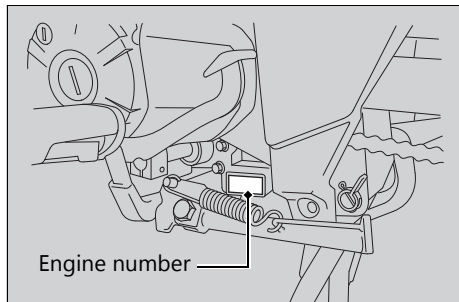
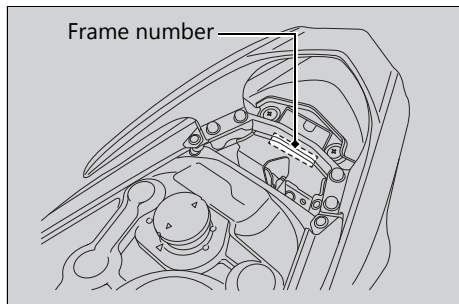

Fuels Containing Alcohol

Some conventional fuels blended with alcohol are available in some locales to help reduce emissions to meet clean air standards. If you plan to use blended fuel, check that it is unleaded and meets the minimum octane rating requirement.

The following fuel blends can be used in your motorcycle:

- Ethanol (ethyl alcohol) up to 10% by volume.
 - ▶ Petrol containing ethanol may be marketed under the name Gasohol.

The use of petrol containing more than 10% ethanol may:

- Damage the painting of the fuel tank.
- Damage the rubber tubes of the fuel line.
- Cause corrosion of the fuel tank.
- Cause poor drivability.

NOTICE

Use of blended fuels containing higher than approved percentages can damage metal, rubber, plastic parts of your fuel system.

If you notice any undesirable operating symptoms or performance problems, try a different brand of petrol.

Catalytic Converter

This motorcycle is equipped with a three-way catalytic converter. The catalytic converter contains precious metals that serve as catalysts in high temperature chemical reactions that convert hydrocarbons (HC), carbon monoxide (CO), and oxides of nitrogen (NOx) in the exhaust gasses into safe compounds.

A defective catalytic converter contributes to air pollution and can impair your engine's performance. A replacement unit must be an original Honda part or equivalent.

Follow these guidelines to protect your motorcycle's catalytic converter.

- Always use unleaded petrol. Leaded petrol will damage the catalytic converter.
- Keep the engine in good running condition.
- Have your motorcycle serviced if your engine is misfiring, backfiring, stalling, or otherwise not running properly, stop riding and turn off the engine.

Specifications

■ Main Components

Overall length	1,933 mm (76.1 in)
Overall width	712 mm (28.0 in)
Overall height	1,093 mm (43.0 in)
Wheelbase	1,258 mm (49.5 in)
Minimum ground clearance	135 mm (5.3 in)
Caster angle	26° 30'
Trail	68 mm (2.7 in)
Curb weight	AFS125MCR 107 kg (236 lb)
	AFS125MCS 106 kg (234 lb)
Maximum weight capacity*1	160 kg (353 lb)
Maximum luggage weight**2	Luggage box 10 kg (22 lb)
Passenger capacity	Driver and 1 passenger
Minimum turning radius	2.00 m (6.56 ft)

*1 Including rider, passenger, all luggage, and accessories.

**2 Includes the weight of the luggage and added accessories.

Displacement	124.89 cm ³ (7.618 cu-in)
Bore × stroke	52.400 × 57.913 mm (2.0630 × 2.2800 in)
Compression ratio	9.3:1
Fuel	Unleaded petrol Recommended: 91 RON or higher
Fuel containing alcohol	ETHANOL up to 10% by volume
Tank capacity	5.4 litres (1.43 US gal, 1.19 Imp gal)
Battery	YTZ4V
	12 V-3 Ah (10 HR)
Gear ratio	1st 2.500
	2nd 1.550
	3rd 1.150
	4th 0.923
Reduction ratio (primary / final)	3.350 / 2.571

Specifications

■ Service Data

Tyre size	Front	70/90-17M/C 38P
	Rear	80/90-17M/C 50P
Tyre type		Bias-ply, tubeless
Recommended Tyres	Front	IRC NF63B Y DUNLOP TT100
	Rear	IRC NR78Y DUNLOP ROADMASTER TT100
Tyre air pressure		(Driver only)
	Front	200 kPa (2.00 kgf/cm ² , 29 psi) (Driver and passenger)
		200 kPa (2.00 kgf/cm ² , 29 psi)
	Rear	(Driver only) 225 kPa (2.25 kgf/cm ² , 33 psi) (Driver and passenger) 280 kPa (2.80 kgf/cm ² , 41 psi)
Spark plug	(standard)	CPR6EA-9 (NGK) U20EPR9 (DENSO)
	(For extend high speed riding)	CPR7EA-9 (NGK) U22EPR9 (DENSO)
Spark plug gap		0.8 to 0.9 mm (0.03 to 0.04 in)
Idle speed		1,400 ± 100 rpm

Recommended engine oil	Honda 4-stroke motorcycle oil API Service Classification SG or higher, excluding oils marked as "Energy Conserving," or "Resource Conserving" SAE 10W-30, JASO T 903 standard MA	
Engine oil capacity	After draining	0.7 litres (0.7 US qt, 0.6 Imp qt)
	After disassembly	0.9 litres (1.0 US qt, 0.8 Imp qt)
Recommended brake fluid	Honda DOT 3 or DOT 4 Brake Fluid	
Recommended drive chain lubricant	Drive chain lubricant. If not available, use SAE 80 or 90 gear oil.	
Drive chain slack	25 to 35 mm (1.0 to 1.4 in)	
Standard drive chain	RK 420EL KMC 420JB	
	No. of links	108
Standard sprocket size	Drive sprocket	14T
	Driven sprocket	36T

■ Bulbs

Headlight	LED
Brakelight/Taillight/ License plate light	12 V-21/5 W
Front turn signal	12 V-10 W x 2
Rear turn signal	12 V-10 W x 2
Position light	12 V-5 W x 2

■ Fuses

Main fuse	20 A
Other fuse	10 A

■ Torque Specifications

Engine oil drain bolt		24 N·m (2.4 kgf·m, 18 lbf·ft)
Front wheel axle nut		59 N·m (6.0 kgf·m, 44 lbf·ft)
Brake stopper arm nut	AFS125MCS	22 N·m (2.2 kgf·m, 16 lbf·ft)
Rear wheel axle nut		59 N·m (6.0 kgf·m, 44 lbf·ft)

A		
Accessories	10	
B		
Battery	38, 49	
Brakelight Switch	62	
Brakes		
Fluid	57	
Pad Wear	58	
Shoe Wear	61	
Braking	7	
Bulb		
Brakelight/Taillight/License Plate Light	84	
Front Turn Signal	85	
Headlight	82	
Position Light	83	
Rear Turn Signal	86	
C		
Caring for Your Motorcycle	93	
Catalytic Converter	100	
Compartment		
Owner's Manual	31, 92	
		Tool Kit
		31
D		
Drive Chain	42, 64	
E		
Electrical Trouble	81	
Engine		
Number	98	
Oil	41, 54	
Starting	23	
Environment	97	
F		
Flooded Engine	25	
Frame Number	98	
Fuel		
Gauge	18	
Recommended	27	
Remaining	18	
Tank Capacity	27	
Fuels Containing Alcohol	99	
Fuses	40, 87	

G

Gasohol	99
Gear Position Indicators	19

H

Headlight Aim	69
Headlight Dimmer Switch	20
Helmet Holder	30
High Beam Indicator	19
Horn Button	20

I

Ignition Key	91
Ignition Switch	21, 23
Indicators	19
Instruments	18

L

Load Limits	11
Loading Guidelines	11
Luggage Box	31

M**Maintenance**

Fundamentals	37
Importance	33
Safety	33
Schedule	34
Maximum Luggage Weight	11
Maximum Weight Capacity	11
Modifications	10

N

Neutral Indicator	19
-------------------------	----

O

Odometer	18
Oil	
Engine	41, 54

P	
Parking	8
Parts Location	14
Petrol	27, 99
PGM-FI (Programmed Fuel Injection)	
Malfunction Indicator Lamp (MIL)	19, 72
Protective Apparel	6
R	
Recommended	
Fuel	27
Oil	41
Refuelling	27
Riding Precautions	7
S	
Safety Precautions	6
Serial Numbers	98
Shifting Gears	26
Side Stand	63
Specifications	101
Speedometer	18
Start Button	20, 23
Starting the Engine	23
Steering Lock	21
Storage	
Equipment	29
Luggage Box	31
Owner's Manual	31, 92
Storing Your Motorcycle	96
Switches	20
T	
Throttle	68
Tool	48
Transporting Your Motorcycle	96
Troubleshooting	70
Turn Signal Indicators	19
Turn Signal Switch	20
Tyres	
Air Pressure	44
Puncture	73
Replacing	44, 73

W

Washing Your Motorcycle93

Weight Limit11

Wheels

Front Removal74

Rear Removal76, 79



38K73A20
00X38-K73-A200

Boon Siew Honda Sdn. Bhd.
(676896-A)